

09-937314
02-27-04

(12) INTERNATIONAL APPLICATION PUBLISHED UNDER THE PATENT COOPERATION TREATY (PCT)

(19) World Intellectual Property Organization
International Bureau



(43) International Publication Date
21 November 2002 (21.11.2002)

PCT

(10) International Publication Number
WO 02/092047 A1

- (51) International Patent Classification⁷: **A61K 7/48**
- (21) International Application Number: PCT/US01/15279
- (22) International Filing Date: 10 May 2001 (10.05.2001)
- (25) Filing Language: English
- (26) Publication Language: English
- (71) Applicant: **THE PROCTER & GAMBLE COMPANY**
[US/US]; One Procter & Gamble Plaza, Cincinnati, OH 45202 (US).
- (72) Inventors: **KASHIHARA, Hiromitsu**; 7-8-1, Morikita-machi, Higashinada-ku, Kobe, Hyogo 658-0001 (JP). **MASUDA, Hisatoshi**; 432-16 Imajuku-cho, Moriyama-shi, Shiga 524-0046 (JP). **SUGIE, Akio**; 11-3-104 Nishikura-cho, Ashiya-shi, Hyogo 659-0026 (JP).
- (74) Agents: **REED, T., David** et al.; The Procter & Gamble Company, 5299 Spring Grove Avenue, Cincinnati, OH 45217-1087 (US).
- (81) Designated States (*national*): AE, AG, AL, AM, AT (utility model), AT, AU, AZ, BA, BB, BG, BR, BY, BZ, CA, CH, CN, CO, CR, CU, CZ (utility model), CZ, DE (utility model), DE, DK (utility model), DK, DM, DZ, EE (utility model), EE, ES, FI (utility model), FI, GB, GD, GE, GH, GM, HR, HU, ID, IL, IN, IS, JP, KE, KG, KP, KR, KZ, LC, LK, LR, LS, LT, LU, LV, MA, MD, MG, MK, MN, MW, MX, MZ, NO, NZ, PL, PT, RO, RU, SD, SE, SG, SI, SK (utility model), SK, SL, TJ, TM, TR, TT, TZ, UA, UG, UZ, VN, YU, ZA, ZW.
- (84) Designated States (*regional*): ARIPO patent (GH, GM, KE, LS, MW, MZ, SD, SL, SZ, TZ, UG, ZW), Eurasian patent (AM, AZ, BY, KG, KZ, MD, RU, TJ, TM), European patent (AT, BE, CH, CY, DE, DK, ES, FI, FR, GB, GR, IE, IT, LU, MC, NL, PT, SE, TR), OAPI patent (BF, BJ, CF, CG, CI, CM, GA, GN, GW, ML, MR, NE, SN, TD, TG).

Published:
— with international search report

For two-letter codes and other abbreviations, refer to the "Guidance Notes on Codes and Abbreviations" appearing at the beginning of each regular issue of the PCT Gazette.



WO 02/092047 A1

(54) Title: COSMETIC COMPOSITION COMPRISING SILICONE ELASTOMER

(57) Abstract: Disclosed is a cosmetic composition comprising: a solid silicone elastomer powder; a water soluble polymer; a water soluble humectant; a nonvolatile silicone compound; and aqueous carrier; wherein the composition has an aqueous continuous phase in a non-emulsified form.

COSMETIC COMPOSITION COMPRISING SILICONE ELASTOMER

5

TECHNICAL FIELD

10 The present invention relates to cosmetic compositions comprising a silicone elastomer, which provides improved coverage of wrinkles, fine lines, and pores while providing a good feel to the skin. In particular, the present invention relates to foundation base products which provide the benefit above.

BACKGROUND

15 A foundation composition can be applied to the face and other parts of the body to even skin tone and texture and to hide pores, imperfections, fine lines, wrinkles, and the like. A foundation composition is also applied to moisturize the skin, to balance the oil level of the skin, and to provide protection against the adverse effects of sunlight, wind, and other environmental factors. The
20 increasing aged population has an increased need to cover and/or hide wrinkles, fine lines, and pores.

"Foundation base" products are products to be applied on the skin prior to applying the foundation, and are increasing popularity in Asian countries such as Japan. Foundation bases are used for enhancing the performance of the
25 foundation, and thus are typically designed for increasing spreadability of the foundation and increasing attachment of the foundation. Some foundation bases further provide tone and color improvement, and UV protection. Foundation bases should not affect the performance of the foundation to be applied on top of it. In this respect, it is generally desirable that the foundation base has
30 controlled affinity and solubility with the foundation.

Solid silicone elastomer powders have been suggested for use in cosmetic compositions, such as in Japanese A-patent publications 7-196815, 9-20631, 11-335228, 11-335242, 11-335254, 11-335259, 7-330537, 8-319215, 9-71509, 9-175940, 9-315936, 10-45536, 10-130120, 10-158121, 10-338616, 11-
35 60445, 11-158030, 11-180827, 2000-7551, and PCT publications WO96/18374, WO98/00104, and WO98/00105. There is a need to provide improved

moisturization effect for such cosmetic compositions, to make the compositions suitable for the drier skin of the aged population.

In order to maintain or return skin to a healthy and/or youthful state, the skin is typically treated with a moisturizing agent. Known moisturizing agents include, for example, glycerin. Increasing the level of moisturizing agent applied to the skin typically provides improved moisturization of the skin. Popular forms of skin care products employed for skin moisturization include clear lotions, milk lotions, and essences. Such compositions typically have a high water content. Thus, consumers expect such high water content compositions to have a non-greasy feeling. Unfortunately, as the percentage of moisturizing agent is increased in such compositions, these compositions tend to impart a greasy feeling and result in poor distribution/spreading of the moisturizing agent to the skin. Further, effective skin treatment agents such as panthenol and niacinamide tend to provide a tacky feeling when incorporated in an aqueous composition.

Based on the foregoing, there is a need for an aqueous cosmetic composition which provides improved coverage and hiding of wrinkles, fine lines, and pores, provides improved moisturizing effect, while also providing a smooth, light feeling to the skin. There is further a need for such composition which is suitable as a foundation base product. There is further a need for such a composition having additional benefits such as improved skin treatment effect, and/or whitening benefit.

None of the existing art provides all of the advantages and benefits of the present invention.

SUMMARY

The present invention is directed to a cosmetic composition comprising:

- (1) a solid silicone elastomer powder;
- (2) a water soluble polymer;
- (3) a water soluble humectant;
- (4) a nonvolatile silicone compound; and
- (5) an aqueous carrier;

wherein the composition has an aqueous continuous phase in a non-emulsified form.

These and other features, aspects, and advantages of the present invention will become evident to those skilled in the art from a reading of the

present disclosure.

DETAILED DESCRIPTION

5 While the specification concludes with claims which particularly point out and distinctly claim the invention, it is believed the present invention will be better understood from the following description.

All cited references are incorporated herein by reference in their entireties. Citation of any reference is not an admission regarding any determination as to its availability as prior art to the claimed invention.

10 Herein, "comprising" means that other steps and other ingredients which do not affect the end result can be added. This term encompasses the terms "consisting of" and "consisting essentially of".

All percentages, parts and ratios are based upon the total weight of the compositions of the present invention, unless otherwise specified. All such weights as they pertain to listed ingredients are based on the active level and, therefore, do not include carriers or by-products that may be included in commercially available materials.

The aspects and embodiments of the present invention set forth in this document have many advantages. For example, the cosmetic composition of the present invention provides improved coverage and hiding of wrinkles, fine lines, and pores, provides improved moisturizing effect, while also providing a smooth, light feeling to the skin. In one embodiment, the cosmetic composition of the present invention also provides improved skin treatment effect. In another embodiment, the cosmetic composition of the present invention also provides whitening benefit.

25 The cosmetic compositions herein are particularly suitable for use in the form of foundation bases, foundations, and facial fluids, preferably foundation bases.

SOLID SILICONE ELASTOMER POWDER

30 The compositions of the present invention comprise a solid silicone elastomer powder, preferably at a level of from about 1% to about 30%, more preferably from about 5% to about 15%. The solid silicone elastomer powders herein are those which have a solid structure, have good water repellency, thus have good flowability and non-agglomerating characters, even in an aqueous environment. The solid silicone elastomer powder herein is to be distinguished

35

from silicone elastomers which provide a gel when in contact with silicone oils. The solid silicone elastomer powder herein is also to be distinguished from silicone elastomers which swell when in contact with water. Particularly useful are those which are spherical and have a particle size of from about 0.1 μ m to about 100 μ m, preferably from about 1 μ m to about 30 μ m. Without being bound by theory, it is believed the solid silicone elastomer powders herein are effectively deposited on the skin, particularly filling wrinkles, fine lines and pores, and provides diffused reflection, thereby covers and/or hides such imperfections. It is believed the elastomeric and preferably spherical structure of the solid silicone elastomer powder herein provides a soft, smooth, and light feeling to the skin.

Particularly useful herein as solid silicone elastomer powders are fine particles of a silicone rubber of which the particles have a composite structure as disclosed in EP 661,334 A publication. These fine particles of a silicone rubber of which the particles have a composite structure consist of a spherical or globular particle of a cured silicone rubber having an average particle diameter in the range from 0.1 to 100 μ m and a coating layer of a polyorganosilsesquioxane resin, the coating amount of the polyorganosilsesquioxane resin being in the range from 1 to 500 parts by weight per 100 parts by weight of the silicone rubber particles before coating.

The above defined silicone resin-coated silicone rubber particles can be prepared by a method which comprises the step of: admixing an aqueous dispersion of particles of a cured silicone rubber having an average particle diameter in the range from 0.1 to 100 μ m with an alkaline compound and a trialkoxy silane compound represented by the general formula $R^2Si(OR^1)_3$, in which R² is an unsubstituted or substituted monovalent hydrocarbon group having 1-20 carbon atoms and R¹ is an alkyl group having 1 to 6 carbon atoms, in combination at a temperature not exceeding 60°C under agitation.

These fine particles are characterized by the composite structure of the particles consisting of a cured silicone rubber particle having a specified average particle diameter and a coating layer thereon formed from a polyorganosilsesquioxane resin in a specified coating amount and the coated silicone rubber particles can be prepared by the in situ hydrolysis and condensation reaction of a trialkoxy silane compound in the presence of cured silicone rubber particles in an aqueous dispersion so as to form the coating layer of a polyorganosilsesquioxane resin on the surface of the silicone rubber

particles.

The silicone rubber forming the fine core particles, on which the coating layer of the polyorganosilsesquioxane resin is formed, is a cured diorganopolysiloxane having linear diorganopolysiloxane segments represented by the general formula in which each R is, independently from the others, an unsubstituted or substituted monovalent hydrocarbon group having 1 to 20 carbon atoms exemplified by alkyl groups such as methyl, ethyl, propyl and butyl groups, aryl groups such as phenyl and tolyl groups, alkenyl groups such as vinyl and allyl groups and aralkyl groups such as 2-phenylethyl and 2-phenylpropyl groups as well as those substituted hydrocarbon groups obtained by replacing a part or all of the hydrogen atoms in the above named hydrocarbon groups with substituents including halogen atoms, epoxy group, amino group, mercapto group, (meth)acryloxy group and the like such as chloromethyl and 3,3,3-trifluoropropyl groups, at least 90% by moles of the groups R being preferably methyl groups, and the subscript a is a positive integer in the range, though not particularly limitative, from 5 to 5000 or, preferably, from 10 to 1000. Such value of the subscript is selected so that the silicone rubber particles after coating with the silicone resin can impart the matrix material compounded therewith with an adequate internal stress and improved surface lubricity while, difficulties are not encountered in the preparation of silicone rubber particles. It is optional that the silicone rubber forming the fine particles is compounded with a silicone oil, organosilane compound, inorganic and organic powders and the like.

It is particularly useful to have the silicone rubber particles coated with a coating layer of the silicone resin have an average particle diameter in the range from 0.1 to 100 μm or, preferably, from 1 to 30 μm . Such average particle diameter of the silicone rubber particles is advantageous for providing suitable flowability of the particles without increased agglomeration while, not affecting surface lubricity of the shaped articles of a composition compounded with the silicone resin-coated silicone rubber particles, or physical properties of the shaped articles.

Commercially available solid silicone elastomer powders highly useful herein include vinyl dimethicone/methicone silsesquioxane crosspolymer with tradenames KSP series available from ShinEtsu Chemical Co., Ltd., Tokyo Japan, and hardened polyorgano siloxane elastomers with tradenames Trefil series available from Toray Dow Corning.

WATER SOLUBLE POLYMER

The compositions of the present invention comprise a water soluble polymer, preferably at a level of from about 0.1% to about 1%. The water soluble polymers herein are water soluble or water miscible polymers, have the ability to increase the viscosity of the composition, and are compatible with the remaining components. The water soluble polymers herein are useful for dispersing solid silicone elastomer powder and other silicone components in the aqueous carrier in a stable manner, so that such components do not separate out. The water soluble polymers also provide a suitable viscosity and rheology to the composition for ease of spreading the composition upon use.

Water soluble polymers useful herein include anionic polymers and nonionic polymers. Useful herein are vinyl polymers such as cross linked acrylic acid polymers with the CTFA name Carbomer, cellulose derivatives and modified cellulose polymers such as methyl cellulose, ethyl cellulose, hydroxyethyl cellulose, hydroxypropyl methyl cellulose, nitro cellulose, sodium cellulose sulfate, sodium carboxymethyl cellulose, crystalline cellulose, cellulose powder, polyvinylpyrrolidone, polyvinyl alcohol, guar gum, hydroxypropyl guar gum, xanthan gum, arabia gum, tragacanth, galactan, carob gum, guar gum, karaya gum, carragheenin, pectin, agar, quince seed (*Cydonia oblonga* Mill), starch (rice, corn, potato, wheat), algae colloids (algae extract), microbiological polymers such as dextran, succinoglucan, pulleran, starch-based polymers such as carboxymethyl starch, methylhydroxypropyl starch, alginic acid-based polymers such as sodium alginate, alginic acid propylene glycol esters, acrylate polymers such as sodium polyacrylate, polyethylacrylate, polyacrylamide, polyethyleneimine, and inorganic water soluble material such as bentonite, aluminum magnesium silicate, laponite, hectonite, and anhydrous silicic acid.

Polyalkylene glycols having a molecular weight of more than about 1000 are useful herein. Useful are those having the following general formula:

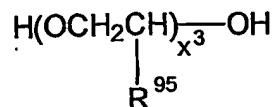

wherein R^{95} is selected from the group consisting of H, methyl, and mixtures thereof. When R^{95} is H, these materials are polymers of ethylene oxide, which are also known as polyethylene oxides, polyoxyethylenes, and polyethylene glycols. When R^{95} is methyl, these materials are polymers of propylene oxide, which are also known as polypropylene oxides, polyoxypropylenes, and

polypropylene glycols. When R⁹⁵ is methyl, it is also understood that various positional isomers of the resulting polymers can exist. In the above structure, x3 has an average value of from about 1500 to about 25,000, preferably from about 2500 to about 20,000, and more preferably from about 3500 to about 15,000.

5 Other useful polymers include the polypropylene glycols and mixed polyethylene-polypropylene glycols, or polyoxyethylene-polyoxypropylene copolymer polymers,. Polyethylene glycol polymers useful herein are PEG-2M wherein R⁹⁵ equals H and x3 has an average value of about 2,000 (PEG-2M is also known as Polyox WSR[®] N-10, which is available from Union Carbide and as PEG-2,000);
10 PEG-5M wherein R⁹⁵ equals H and x3 has an average value of about 5,000 (PEG-5M is also known as Polyox WSR[®] N-35 and Polyox WSR[®] N-80, both available from Union Carbide and as PEG-5,000 and Polyethylene Glycol 300,000); PEG-7M wherein R⁹⁵ equals H and x3 has an average value of about 7,000 (PEG-7M is also known as Polyox WSR[®] N-750 available from Union
15 Carbide); PEG-9M wherein R⁹⁵ equals H and x3 has an average value of about 9,000 (PEG 9-M is also known as Polyox WSR[®] N-3333 available from Union Carbide); and PEG-14 M wherein R⁹⁵ equals H and x3 has an average value of about 14,000 (PEG-14M is also known as Polyox WSR[®] N-3000 available from Union Carbide).

20 Commercially available water soluble polymers highly useful herein include xanthan gum with tradename Keltrol series available from Kelco, Carbomers with tradenames Carbopol 934, Carbopol 940, Carbopol 950, Carbopol 980, and Carbopol 981, all available from B. F. Goodrich Company, acrylates/stearth-20 methacrylate copolymer with tradename ACRY SOL 22
25 available from Rohm and Hass, nonoxynyl hydroxyethylcellulose with tradename AMERCELL POLYMER HM-1500 available from Amerchol, methylcellulose with tradename BENECEL, hydroxyethyl cellulose with tradename NATROSOL, hydroxypropyl cellulose with tradename KLUCEL, cetyl hydroxyethyl cellulose with tradename POLYSURF 67, all supplied by Hercules, ethylene oxide and/or
30 propylene oxide based polymers with tradenames CARBOWAX PEGs, POLYOX WASRs, and UCON FLUIDS, all supplied by Amerchol.

The carboxylic acid/carboxylate copolymers are useful as water soluble polymers herein. These copolymers are hydrophobically-modified cross-linked copolymers of carboxylic acid and alkyl carboxylate, and have an amphiphilic
35 property. These carboxylic acid/carboxylate copolymers are obtained by

copolymerizing 1) a carboxylic acid monomer such as acrylic acid, methacrylic acid, maleic acid, maleic anhydride, itaconic acid, fumaric acid, crotonic acid, or α -chloroacrylic acid, 2) a carboxylic ester having an alkyl chain of from 1 to about 30 carbons, and preferably 3) a crosslinking agent of the following formula:

5

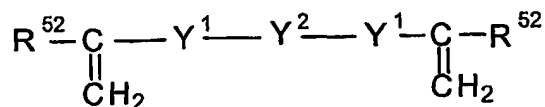

wherein R^{52} is a hydrogen or an alkyl group having from about 1 to about 30 carbons; Y^1 , independently, is oxygen, CH_2O , COO , OCO ,

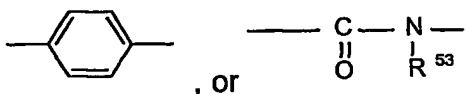

10

having from about 1 to about 30 carbons; and Y^2 is selected from $(\text{CH}_2)_{m''}$, $(\text{CH}_2\text{CH}_2\text{O})_{m''}$, or $(\text{CH}_2\text{CH}_2\text{CH}_2\text{O})_{m''}$ wherein m'' is an integer of from 1 to about 30. It is believed that, because of the alkyl group contained in the copolymer, the carboxylic acid/carboxylate copolymers do not make the composition undesirably sticky.

15

Suitable carboxylic acid/carboxylate copolymers herein are acrylic acid/alkyl acrylate copolymers having the following formula:

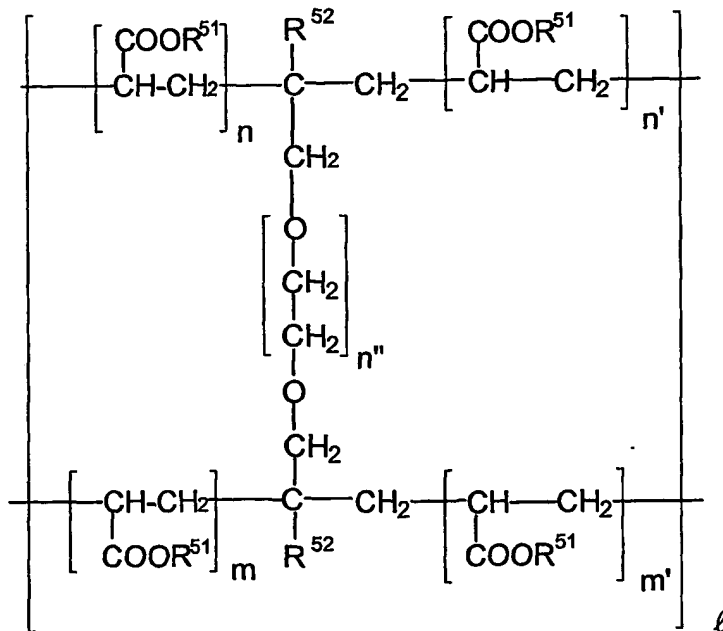

wherein R^{51} , independently, is a hydrogen or an alkyl of 1 to 30 carbons wherein at least one of R^{51} is a hydrogen, R^{52} is as defined above, n , n' , m and m' are integers in which $n+n'+m+m'$ is from about 40 to about 100, n'' is an integer of from 1 to about 30, and ℓ is defined so that the copolymer has a molecular weight of about 500,000 to about 3,000,000.

Commercially available carboxylic acid/carboxylate copolymers useful herein include: CTFA name Acrylates/C10-30 Alkyl Acrylate Crosspolymer having tradenames Pemulene TR-1, Pemulene TR-2, Carbopol 1342, Carbopol 1382, and Carbopol ETD 2020, all available from B. F. Goodrich Company.

Neutralizing agents may be included to neutralize water soluble polymers of anionic nature. Nonlimiting examples of such neutralizing agents include sodium hydroxide, potassium hydroxide, ammonium hydroxide, monethanolamine, diethanolamine, triethanolamine, diisopropanolamine, aminomethylpropanol, tromethamine, tetrahydroxypropyl ethylenediamine, and mixtures thereof.

WATER SOLUBLE HUMECTANT

The composition of the present invention comprise a water soluble humectant, preferably at a level of from about 1% to about 10%. The water soluble humectants provide moisturizing effect to the skin.

Water soluble humectants useful herein include polyhydric alcohols such as glycerin, sorbitol, propylene glycol, butylene glycol, hexylene glycol, ethoxylated glucose, 1, 2-hexane diol, hexanetriol, dipropylene glycol, erythritol, trehalose, diglycerin, xylitol, maltitol, maltose, glucose, fructose, sodium chondroitin sulfate, sodium hyaluronate, sodium adenosin phosphate, sodium lactate, pyrrolidone carbonate, glucosamine, cyclodextrin, and mixtures thereof.

Water soluble humectants useful herein include water soluble alkoxyated nonionic polymers such as polyethylene glycols and polypropylene glycols having a molecular weight of up to about 1000 such as those with CTFA names PEG-200, PEG-400, PEG-600, PEG-1000, and mixtures thereof.

Commercially available humectants herein include: glycerin with tradenames STAR and SUPEROL available from The Procter & Gamble Company, CRODEROL GA7000 available from Croda Universal Ltd., PRECERIN series available from Unichema, and a same tradename as the chemical name available from NOF; propylene glycol with tradename LEXOL PG-865/855 available from Inolex, 1,2-PROPYLENE GLYCOL USP available

from BASF; sorbitol with tradenames LIPONIC series available from Lipo, SORBO, ALEX, A-625, and A-641 available from ICI, and UNISWEET 70, UNISWEET CONC available from UPI; dipropylene glycol with the same tradename available from BASF; diglycerin with tradename DIGLYCEROL
5 available from Solvay GmbH; xylitol with the same tradename available from Kyowa and Eizai; maltitol with tradename MALBIT available from Hayashibara, sodium chondroitin sulfate with the same tradename available from Freeman and Bioiberica, and with tradename ATOMERGIC SODIUM CHONDROITIN
10 SULFATE available from Atomergic Chemetals; sodium hyaluronate with tradenames ACTIMOIST available from Active Organics, AVIAN SODIUM HYALURONATE series available from Intergen, HYALURONIC ACID Na available from Ichimaru Pharcos; sodium adenosin phosphate with the same tradename available from Asahikasei, Kyowa, and Daiichi Seiyaku; sodium lactate with the same tradename available from Merck, Wako, and Showa Kako,
15 cyclodextrin with tradenames CAVITRON available from American Maize, RHODOCAP series available from Rhone-Poulenc, and DEXPEARL available from Tomen; and polyethylene glycols with the tradename CARBOWAX series available from Union Carbide.

NONVOLATILE SILICONE COMPOUND

20 The compositions of the present invention comprise a nonvolatile silicone compound, preferably at a level of from about 1% to about 10%, more preferably from about 3% to about 6% of a nonvolatile silicone compound. The nonvolatile silicone compound herein has affinity with the solid silicone elastomer powder herein. Thus, after the present composition is applied to the skin and volatile
25 components such as water is evaporated from the skin, the nonvolatile silicone compound forms a film on the skin entrapping the solid silicone elastomer powder.

The silicone components described below include the nonvolatile silicone compound useful herein. The silicone components can be soluble or insoluble.
30 By insoluble what is meant is that the silicone forms a separate, discontinuous phase from the carrier, such as in the form of an emulsion or a suspension of droplets of the silicone. The silicone components herein may be made by any suitable method known in the art, including emulsion polymerization. The silicone components may further be incorporated in the present composition in
35 the form of an emulsion, wherein the emulsion is made by mechanical mixing, or

in the stage of synthesis through emulsion polymerization, with or without the aid of a surfactant selected from anionic surfactants, nonionic surfactants, cationic surfactants, and mixtures thereof. Silicone components of high molecular weight may be made by emulsion polymerization. Volatile silicone oils may be included in the silicone component, for example, as carriers or solvents for the non-volatile silicone compound. However, volatile silicone oil alone cannot replace the nonvolatile silicone compound. Without the nonvolatile silicone compound forming a film on the skin, the solid silicone elastomer powder is not effectively attached to the skin after evaporation of the volatile components in the composition.

In one preferred embodiment, the present composition is substantially free of volatile silicone oil. Such preferred embodiment is suitable for products aimed for the aged consumers, as volatile silicone oils tend to leave the skin dry.

In another preferred embodiment, the present composition is substantially free of any other oils than the nonvolatile silicone compounds herein. Such preferred embodiment is suitable for products designed as foundation bases. Foundation bases should not affect the performance, particularly the color feature of the foundation to be applied on top of it. Non-silicone oils, particularly ester oils, have good affinity with a large variety of components included in a foundation, thus, have the tendency to wet the foundation and alter its color.

Silicone components useful herein include polyalkyl polyaryl siloxanes, silicone resins, amino-substituted siloxanes, and mixtures thereof. The silicone component is preferably selected from the group consisting of polyalkyl polyaryl siloxanes, silicone resins, and mixtures thereof, and more preferably from one or more polyalkyl polyaryl siloxanes.

Polyalkyl polyaryl siloxanes useful here in include those with the following structure (I)

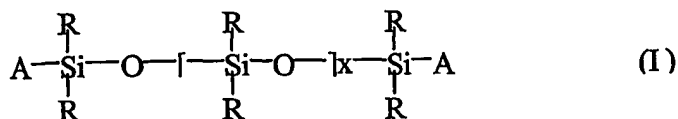

wherein R is alkyl or aryl, and x is an integer from about 7 to about 8,000. "A" represents groups which block the ends of the silicone chains. The alkyl or aryl groups substituted on the siloxane chain (R) or at the ends of the siloxane chains (A) can have any structure as long as the resulting silicone remains fluid at room

temperature, is dispersible, is neither irritating, toxic nor otherwise harmful when applied to the skin, is compatible with the other components of the composition, is chemically stable under normal use and storage conditions, and is capable of being deposited on and conditions the skin. Suitable A groups include hydroxy, methyl, methoxy, ethoxy, propoxy, and aryloxy. The two R groups on the silicon atom may represent the same group or different groups. Preferably, the two R groups represent the same group. Suitable R groups include methyl, ethyl, propyl, phenyl, methylphenyl and phenylmethyl. The preferred silicone compounds are polydimethylsiloxane, polydiethylsiloxane, and polymethylphenylsiloxane. Polydimethylsiloxane, which is also known as dimethicone, is especially preferred. The polyalkylsiloxanes that can be used include, for example, polydimethylsiloxanes. These silicone compounds are available, for example, from the General Electric Company in their ViscasilR and SF 96 series, and from Dow Corning in their Dow Corning 200 series. Polymethylphenylsiloxanes, for example, from the General Electric Company as SF 1075 methyl phenyl fluid or from Dow Corning as 556 Cosmetic Grade Fluid, are useful herein.

Another polyalkyl polyaryl siloxane that can be especially useful is a silicone gum. The term "silicone gum", as used herein, means a polyorganosiloxane material having a viscosity at 25°C of greater than or equal to 1,000,000 centistokes. It is recognized that the silicone gums described herein can also have some overlap with the above-disclosed silicone compounds. This overlap is not intended as a limitation on any of these materials. Silicone gums are described by Petrarch, and others including U.S. Patent No. 4,152,416, to Spitzer et al., issued May 1, 1979 and Noll, Walter, Chemistry and Technology of Silicones, New York: Academic Press 1968. Also describing silicone gums are General Electric Silicone Rubber Product Data Sheets SE 30, SE 33, SE 54 and SE 76. All of these described references are incorporated herein by reference in their entirety. The "silicone gums" will typically have a mass molecular weight in excess of about 200,000, generally between about 200,000 and about 1,000,000. Specific examples include polydimethylsiloxane, poly(dimethylsiloxane methylvinylsiloxane) copolymer, poly(dimethylsiloxane diphenylsiloxane methylvinylsiloxane) copolymer and mixtures thereof.

Also useful are silicone resins, which are highly crosslinked polymeric siloxane systems. The crosslinking is introduced through the incorporation of tri-

functional and tetra-functional silanes with mono-functional or di-functional, or both, silanes during manufacture of the silicone resin. As is well understood in the art, the degree of crosslinking that is required in order to result in a silicone resin will vary according to the specific silane units incorporated into the silicone resin. In general, silicone materials which have a sufficient level of trifunctional and tetrafunctional siloxane monomer units, and hence, a sufficient level of crosslinking, such that they dry down to a rigid, or hard, film are considered to be silicone resins. The ratio of oxygen atoms to silicon atoms is indicative of the level of crosslinking in a particular silicone material. Silicone materials which have at least about 1.1 oxygen atoms per silicon atom will generally be silicone resins herein. Preferably, the ratio of oxygen:silicon atoms is at least about 1.2:1.0. Silanes used in the manufacture of silicone resins include monomethyl-, dimethyl-, trimethyl-, monophenyl-, diphenyl-, methylphenyl-, monovinyl-, and methylvinylchlorosilanes, and tetrachlorosilane, with the methyl substituted silanes being most commonly utilized. Preferred resins are offered by General Electric as GE SS4230 and SS4267. Commercially available silicone resins will generally be supplied in a dissolved form in a low viscosity volatile or nonvolatile silicone fluid. The silicone resins for use herein should be supplied and incorporated into the present compositions in such dissolved form, as will be readily apparent to those skilled in the art. Without being bound by theory, it is believed that the silicone resins can enhance deposition of other silicone components on the skin.

The method of manufacturing these silicone components, can be found in Encyclopedia of Polymer Science and Engineering, Volume 15, Second Edition, pp. 204-308, John Wiley & Sons, Inc., 1989.

In one preferred embodiment, the silicone component is a mixture of high viscosity silicone compounds and silicone based carriers.

High viscosity silicone compounds herein include those having a molecular weight of from about 200,000 to about 540,000 selected from those mentioned above, preferably selected from the group consisting of dimethiconol, fluorosilicone dimethicone, and mixtures thereof, more preferably essentially dimethiconol. Particularly preferred dimethiconols are those having dimethylpolysiloxane repeating units, and terminated with hydroxy groups, wherein the dimethylsiloxane portion is made of from about 2700 to about 4500 repeating units.

Silicone based carriers include those having a viscosity of from about 0.65 mPa•s to about 100 mPa•s selected from cyclomethicones and dimethicones having lower repeating units.

Commercially available silicone components which are useful herein include Dimethicone with tradename DC345 available from Dow Corning Corporation, Dimethicone gum solutions with tradenames SE 30, SE 33, SE 54 and SE 76 available from General Electric, Dimethiconol with tradenames DCQ2-1403 and DCQ2-1401 available from Dow Corning Corporation, and emulsion polymerized Dimethiconol available from Toshiba Silicone as described in GB application 2,303,857.

AQUEOUS CARRIER

The compositions of the present invention comprise an aqueous carrier. The level and species of the carrier are selected according to the compatibility with other components, and other desired characteristic of the product.

Carriers useful in the present invention include water and water solutions of lower alkyl alcohols. Lower alkyl alcohols useful herein are monohydric alcohols having 1 to 6 carbons, more preferably ethanol and isopropanol. Preferably, the aqueous carrier is substantially water. Preferably, water is included at a level of from about 70% to about 90%, more preferably from about 70% to about 80%. Deionized water is preferably used. Water from natural sources including mineral cations can also be used, depending on the desired characteristic of the product.

The compositions of the present invention have an aqueous continuous phase, and are in a non-emulsified form. It is believed such product form is advantageous in delivering the water soluble components such as water soluble humectants and optional tacky skin treatment agents, as well as the solid silicone elastomer powder. Without being bound by theory, it is also believed that the inclusion of surfactant for making an emulsion, for example an oil-in-water emulsion, affects the wear resistance of the composition. Foundation bases should not affect the performance and stability of the foundation to be applied on top of it. Foundation bases that do not have a certain degree of wear resistance will mingle with the foundation, when the foundation is applied on the skin. Emulsions have a higher tendency to wet the foundation and alter its color, or affect the stability of the foundation when mingled with the foundation. Preferably, the present composition is substantially free of surfactants.

TACKY SKIN TREATMENT AGENT

The composition of the present invention may additionally comprise from about 0.1% to about 10%, preferably from about 1% to about 10% of a tacky skin treatment agent. Skin treatment agents useful herein are those which help repair and replenish the natural moisture barrier function of the epidermis, thereby providing skin benefits such as texture improvement. It is generally known that, while such agents provide useful benefits to the skin when used chronically, they also tend to provide negative skin feel upon use when applied by itself. By definition, chronic is referred to continued topical application of the composition over an extended period during the subject's lifetime, preferably for a period of at least about one week, more preferably for a period of at least about one month, even more preferably for at least about three months, even more preferably for at least about one year. Typically, applications would be on the order of about once per day over such extended periods, while application rates can vary from about once per week up to about three times per day or more.

Tacky skin treatment agents useful herein are niacinamide, nicotinic acid and its esters, nicotinyl alcohol, panthenol, panthenyl ethyl ether, n-acetyl cysteine, n-acetyl-L-serine, phosphodiesterase inhibitors, trimethyl glycine, tocopheryl nicotinate, and vitamin D3 and analogues or derivatives, and mixtures thereof. Niacinamide is particularly preferred in that, when used in a pharmaceutically effective amount, is capable of reducing or alleviating the intensity of chronic spots. Panthenol is also particularly preferred in that, when used in an amount of at least about 1%, it provides texture improvement benefits. Niacinamide and panthenol are commercially available, for example, by Roche.

WHITENING AGENT

The composition of the present invention may additionally comprise from about 0.001% to about 10%, more preferably from about 0.1% to about 5% of a whitening agent. Whitening agents useful herein are those which are compatible with the aqueous form of the present composition. Water soluble whitening agents are preferred. For the aged population, whitening is also a highly desirable function for a cosmetic product. The whitening agent useful herein refers to active ingredients that not only alter the appearance of the skin, but further improve hyperpigmentation as compared to pre-treatment.

Useful whitening agents useful herein include ascorbic acid compounds, azelaic acid, butyl hydroxy anisole, gallic acid and its derivatives, glycyrrhizinic acid, hydroquinone, kojic acid, arbutin, mulberry extract, and mixtures thereof. Use of combinations of whitening agents are believed to be advantageous in that they may provide whitening benefit through different mechanisms.

Ascorbic acid compounds are useful whitening agents, and have the formula (I):

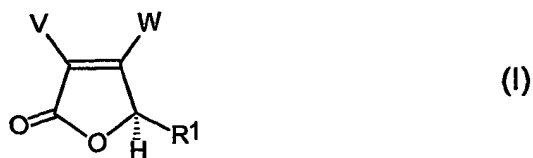

wherein V and W are independently -OH; R¹ is -CH(OH)-CH₂OH; and salts thereof.

Preferably, the ascorbic acid compound useful herein is an ascorbic acid salt or derivative thereof, such as the non-toxic alkali metal, alkaline earth metal and ammonium salts commonly known by those skilled in the art including, but not limited to, the sodium, potassium, lithium, calcium, magnesium, barium, ammonium and protamine salts which are prepared by methods well known in the art.

More preferably, the ascorbic acid salt useful herein is a metal ascorbate having the following formula (II):

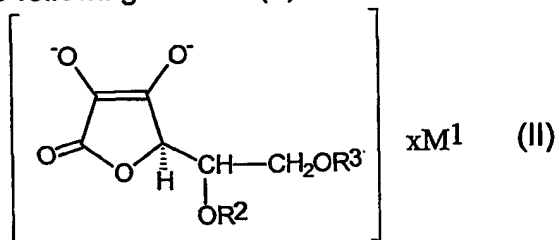

wherein R² and R³ are independently selected from hydrogen and linear or branched alkyl of 1 to about 8 carbons; M¹ is a metal; and x is an integer of from 1 to about 3. More preferably, R² and R³ are independently selected from hydrogen and linear or branched alkyl of 1 to about 3 carbons; M¹ is sodium, potassium, magnesium, or calcium.

Examples of other preferred ascorbic acid salts having formula (II) include monovalent metal salts (e.g., sodium ascorbate, potassium ascorbate), divalent metal salts (e.g., magnesium ascorbate, calcium ascorbate) and trivalent metal salts (e.g., aluminum ascorbate) of ascorbic acid.

Preferably, the ascorbic acid salt useful herein is a water soluble ascorbyl ester having the following formula (III):

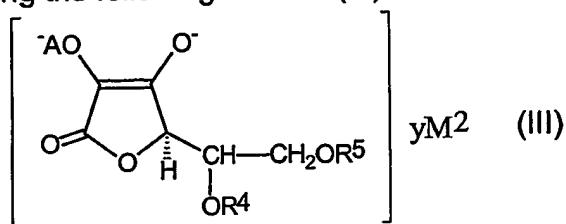

wherein A is sulfate or phosphate; R⁴ and R⁵ are independently selected from hydrogen and linear or branched alkyl of 1 to about 8 carbons; M² is a metal; and y is an integer of 1 to about 3. More preferably, R⁴ and R⁵ are independently selected from hydrogen and linear or branched alkyl of 1 to about 3 carbons; M² is sodium, potassium, magnesium, or calcium.

Another particularly preferred ascorbic acid compound is 2-o- α -D-glucopyranosyl-L-ascorbic acid, usually referred to as L-ascorbic acid 2-glucoside or ascorbyl glucoside, and its metal salts. Such compounds are available from Hayashibara.

Exemplary water soluble salt derivatives include, but are not limited to, L-ascorbic acid 2-glucoside, L-ascorbyl phosphate ester salts such as sodium L-ascorbyl phosphate, potassium L-ascorbyl phosphate, magnesium L-ascorbyl phosphate, calcium L-ascorbyl phosphate, aluminum L-ascorbyl phosphate. L-ascorbyl sulfate ester salts can also be used. Examples are sodium L-ascorbyl sulfate, potassium L-ascorbyl sulfate, magnesium L-ascorbyl sulfate, calcium L-ascorbyl sulfate and aluminum L-ascorbyl sulfate.

20 PIGMENTS AND DYES

The composition of the present invention may contain a pigment and/or dye. The amount of the pigment and/or dye is controlled so that it is effectively dispersed in the aqueous carrier of the present composition. The pigments and dyes are selected depending on the desired characteristic of the product, for example, whether the product is designed for a foundation or foundation base, shade, coverage, UV protection benefit, and various skin feel.

The pigments useful herein are clay mineral powders such as talc, mica, sericite, silica, magnesium silicate, synthetic fluorphlogopite, calcium silicate, aluminum silicate, bentonite and montomorilonite; inorganic pigments such as alumina, barium sulfate, calcium secondary phosphate, calcium carbonate, titanium oxide, finely divided titanium oxide, zirconium oxide, zinc oxide, hydroxy

apatite, iron oxide, iron titate, ultramarine blue, Prussian blue, chromium oxide, chromium hydroxide, cobalt oxide, cobalt titanate, titanium oxide coated mica; organic powders such as polyester, polyethylene, polystyrene, methyl methacrylate resin, cellulose, 12-nylon, 6-nylon, styrene-acrylic acid copolymers, poly propylene, vinyl chloride polymer, tetrafluoroethylene polymer, boron nitride, fish scale guanine, laked tar color dyes, and laked natural color dyes.

In one embodiment, hydrophobically treated pigments are contained in the present composition. The hydrophobically treated pigments assist the nonvolatile silicone compound to effectively form a film on the skin entrapping the solid silicone elastomer powder.

Hydrophobically treated pigments useful herein include pigments mentioned above treated with a hydrophobic treatment agent, including: silicone such as Methicone, Dimethicone and perfluoroalkylsilane; fatty material such as stearic acid; metal soap such as aluminium dimyristate; aluminium hydrogenated tallow glutamate, hydrogenated lecithin, lauroyl lysine, aluminium salt of perfluoroalkyl phosphate, and mixtures thereof.

Titanium oxide, zirconium oxide, and zinc oxide of certain particle size and shape are known to provide UV protection benefit. In one embodiment, such pigments having UV protection benefit are contained in the composition of the present invention. Commercially available materials that meet this need include SI Titanium Dioxide IS available from Ishihara Sangyo.

ADDITIONAL COMPONENTS

Other components which can be formulated into the compositions of the present invention are; preservatives such as benzyl alcohol, methyl paraben, propyl paraben, imidazolidinyl urea, and EDTA and its salts, perfumes, ultraviolet and infrared screening and absorbing agents, yeast fermented filtrates, and others.

COMPOSITION

The composition of the present invention is suitable for topical use on human body skin, particularly suitable for facial skin. The cosmetic compositions herein are particularly suitable for use in the form of foundation bases, foundations, and facial fluids, preferably foundation bases.

The cosmetic composition of the present invention provides improved coverage and hiding of wrinkles, fine lines, and pores, provides improved moisturizing effect, while also providing a smooth, light feeling to the skin. In one

embodiment, the cosmetic composition of the present invention additionally provides improved skin treatment effect. In another embodiment, the cosmetic composition of the present invention additionally provides whitening benefit.

- The composition of the present invention may be made by methods known in the art. In a suitable process, the composition is made by the steps of:
- (a) adding the water soluble polymer into at least a portion of water and mixing until homogeneous;
 - (b) adding the nonvolatile silicone compound to the product of step (a) and mixing until homogeneous; and
 - (c) adding the remainder of the composition to the product of step (b).

In step (a), the water soluble polymer is dispersed in water to make the base carrier of the composition. All or portion of the water may be used. Appropriate mixing is provided to make the dispersion homogeneous. Heat may be added. A homogenizer may be used in this step to provide high rotation homogenizing for a short period of time. Preferably, water soluble components such as water soluble humectants, tacky skin treatment agents, and water soluble whitening agents, are included to this carrier. Heat may be added to this step. In step (b), components of hydrophobic nature, i.e. the silicone component and any other oil, if included, is added in the product of step (a), and mixed until homogeneous. Neutralizing agents for the water soluble polymer are added after step (b), when used. Finally the remaining components, including the solid silicone elastomer powder, and remainder of water are added and mixed. The rotation of mixing in steps (b) and (c) should be adjusted so that the obtained mixture is homogenous, yet not overly agitated to affect the performance of the solid silicone elastomer powder. Without being bound by theory, it is believed that overly agitating the solid silicone elastomer powder will destroy or distort its spherical structure, thereby providing compromised performance as to hiding of wrinkles, fine lines, and pores. Preferably, mixing is made at a rotation speed of from about 30 to about 500 rpm in an anchor mixer. Steps (b) and (c) can be carried out at room temperature, and heating is not necessary. If heating aid is applied, the temperature is controlled to from about 30°C to about 40°C.

EXAMPLES

The following examples further describe and demonstrate embodiments within the scope of the present invention. The examples are given solely for the purpose of illustration and are not to be construed as limitations of the present invention, as many variations thereof are possible without departing from the spirit and scope of the invention. Ingredients are identified by chemical or CTFA name, or otherwise defined below.

Compositions

	Ex. 1	Ex. 2	Ex. 3	Ex. 4	Ex. 5
Solid silicone elastomer powder-1 *1	8	10	20	8	
Solid silicone elastomer powder-2 *2					8
Carbomer *3	0.3	0.5	0.3	0.3	0.3
1,3-butylene glycol	6		6	6	3
Glycerin	1	1	1	1	
Hexylene glycol	1		1	1	
Dimethicone/Dimethiconol *4	6	3	6	6	
Cyclomethicone/Dimethiconol *5					6
Panthenol *6	0.25		1	0.25	1
Niacinamide*7	2		5	5	3.5
Farnesol					3
Yeast Ferment Filtrate *8	10		30		
Methyl Paraben	0.175	0.175	0.175	0.175	0.175
EDTA-2Na	0.05		0.05	0.05	0.05
Sodium hydroxide	0.105	0.175	0.105	0.105	0.105
Deionized Water	----- q.s. to 100% -----				

	Ex. 7	Ex. 8	Ex. 9	Ex. 10
Solid silicone elastomer powder-1 *1	5	8	8	8
Carbomer *3	1	0.3	0.3	0.3
1,3-butylene glycol	6	6	6	6
Glycerin	3	1	1	1
Hexylene glycol	1	1	1	1
Dimethicone/Dimethiconol *4	6	10		6
Cyclomethicone/Dimethiconol *5			2	

Panthenol *6	0.25	0.25	0.25	0.25
Niacinamide*7	2	2	2	2
Magnesium Ascorbyl Glucoside *9			1	
Titanium Dioxide *10				2
Phenoxyethanol		0.25		
Methyl Paraben	0.175	0.15	0.175	0.175
EDTA-2Na	0.05	0.05	0.05	0.05
Sodium hydroxide	0.35	0.105	0.105	0.105
Deionized Water	----- q.s. to 100% -----			

Definitions of Components

- *1 Solid silicone elastomer powder-1: KSP-100 available from ShinEtsu Chemicals
- 5 *2 Solid silicone elastomer powder-2: Trefil 506C available from Toray Dow Corning.
- *3 Carbomer: Carbopol 980 available from B. F. Goodrich
- *4 Dimethicone/Dimethiconol: DCQ2-1403 available from Dow Corning
- *5 Cyclomethicone/Dimethiconol: DCQ2-1401 available from Dow Corning
- 10 *6 Panthenol: available from Roche
- *7 Niacinamide: available from Roche
- *8 Yeast Ferment Filtrate: SKII Pitera available from Kashiwayama
- *9 Magnesium Ascorbyl Glucoside: available from Hayashibara
- 15 *10 Titanium Dioxide: SI Titanium dioxide IS available from Ishihara Sangyo

Method of Preparation

Examples 1-10 may be made by a method known in the art, and is suitably made as follows:

20 Water soluble components such as water soluble humectants, and if present, tacky skin treatment agents, preservatives, yeast ferment filtrate and a portion of water is mixed with agitation in an anchor mixer at about 50rpm at about 70°C until homogeneous, and cooled down to about 40°C. Carbomer is added to this mixture, and mixed with agitation in an anchor mixer at about 40rpm. As necessary, a homogenizer may be used at a speed of about 4000rpm

25 for a short period of time. To this mixture, the silicone component is added, and mixed with agitation in an anchor mixer at about 50rpm at about 40°C. The neutralizing agent, if present, is added to the mixture. Finally, the solid silicone

elastomer powder is added, and mixed with agitation in an anchor mixer at about 50rpm at about 40°C, and cooled to room temperature.

5 Examples 1 through 10 are particularly useful as foundation base products for providing improved coverage and hiding of wrinkles, fine lines and pores, and further provides improved moisturizing effect, while also providing a smooth, light feeling to the skin. Example 3 additionally provides improved skin treatment effect over a chronic usage. Example 9 additionally provides improved whitening effect over a chronic usage.

WHAT IS CLAIMED IS:

1. A cosmetic composition comprising:
 - (1) a solid silicone elastomer powder;
 - (2) a water soluble polymer;
 - (3) a water soluble humectant;
 - (4) a nonvolatile silicone compound; and
 - (5) aqueous carrier;wherein the composition has an aqueous continuous phase in a non-emulsified form.

2. The cosmetic composition according to Claim 1 comprising by weight:
 - (1) from about 1% to about 30% of the solid silicone elastomer powder
 - (2) from about 0.1% to about 1% of the water soluble polymer;
 - (3) from about 1% to about 10% of the water soluble humectant;
 - (4) from about 1% to about 10% of the nonvolatile silicone compound; and
 - (5) from about 70% to about 90% water.

3. The cosmetic composition according to Claim 1 further comprising a tacky skin treatment agent.

4. The cosmetic composition according to Claim 3 comprising from about 1% to about 10% of the tacky skin treatment agent selected from the group consisting of niacinamide, panthenol, and mixtures thereof.

5. The cosmetic composition according to Claim 1 further comprising a whitening agent.

6. The cosmetic composition according to Claim 1 further comprising a pigment and/or dye.

7. The cosmetic composition according to Claim 1 substantially free of surfactants.

8. The cosmetic composition according to Claim 1 substantially free of non-

silicone oils.

9. The cosmetic composition according to Claim 1 substantially free of volatile silicone oil.
10. The skin care composition according to any of Claims 1 through 10 wherein the solid silicone elastomer powder is a composite material of silicone rubber and polyorganosilsesquioxane.
11. The skin care composition according to any of Claims 1 through 10 wherein the water soluble polymer is a carboxyvinyl polymer.
12. The skin care composition according to any of Claims 1 through 10 wherein the nonvolatile silicone compound is selected from the group consisting of nonvolatile dimethicone, nonvolatile dimethiconol, and mixtures thereof.
13. A method of improving the performance of a foundation comprising the step of applying to the skin the composition of any of Claims 1 through 12 to the skin, prior to applying the foundation.
14. A method of covering and/or hiding wrinkles, fine lines, and pores comprising the step of applying to the skin the composition of any of Claims 1 through 12.
15. A method of providing chronic skin treatment effect comprising the step of applying to the skin the composition of Claim 3 or 4.
16. A method of providing skin whitening effect comprising the step of applying to the skin the composition of Claim 5.
17. A method of making the composition of any of Claims 1 through 12 comprising the steps of:
 - (a) adding the water soluble polymer into at least a portion of water and mixing until homogeneous;
 - (b) adding the nonvolatile silicone compound to the product of step (a) and

- mixing until homogeneous; and
- (c) adding the remainder of the composition to the product of step (b).

INTERNATIONAL SEARCH REPORT

International Application No

PCT/US 01/15279

A. CLASSIFICATION OF SUBJECT MATTER
 IPC 7 A61K7/48

According to International Patent Classification (IPC) or to both national classification and IPC

B. FIELDS SEARCHED

Minimum documentation searched (classification system followed by classification symbols)
 IPC 7 A61K

Documentation searched other than minimum documentation to the extent that such documents are included in the fields searched

Electronic data base consulted during the International search (name of data base and, where practical, search terms used)

EPO-Internal, WPI Data, PAJ

C. DOCUMENTS CONSIDERED TO BE RELEVANT

Category *	Citation of document, with indication, where appropriate, of the relevant passages	Relevant to claim No.
A	US 5 919 468 A (BARA ISABELLE) 6 July 1999 (1999-07-06) column 5, line 50-65; claims 1-16	1,6, 13-16
A	US 5 928 660 A (MORITA YOSHITSUGU ET AL) 27 July 1999 (1999-07-27) column 6, line 6 column 7, line 20 -column 12, line 60	1
A	WO 98 00105 A (UNILEVER PLC ;UNILEVER NV (NL)) 8 January 1998 (1998-01-08) cited in the application	
A	WO 98 00104 A (UNILEVER PLC ;UNILEVER NV (NL)) 8 January 1998 (1998-01-08) cited in the application	

Further documents are listed in the continuation of box C.

Patent family members are listed in annex.

*** Special categories of cited documents :**

- *A* document defining the general state of the art which is not considered to be of particular relevance
- *E* earlier document but published on or after the international filing date
- *L* document which may throw doubts on priority claim(s) or which is cited to establish the publication date of another citation or other special reason (as specified)
- *O* document referring to an oral disclosure, use, exhibition or other means
- *P* document published prior to the international filing date but later than the priority date claimed

- *T* later document published after the international filing date or priority date and not in conflict with the application but cited to understand the principle or theory underlying the invention
- *X* document of particular relevance; the claimed invention cannot be considered novel or cannot be considered to involve an inventive step when the document is taken alone
- *Y* document of particular relevance; the claimed invention cannot be considered to involve an inventive step when the document is combined with one or more other such documents, such combination being obvious to a person skilled in the art.
- *8* document member of the same patent family

Date of the actual completion of the international search

12 April 2002

Date of mailing of the international search report

24/04/2002

Name and mailing address of the ISA

European Patent Office, P.B. 5818 Patentlaan 2
 NL - 2280 HV Rijswijk
 Tel. (+31-70) 340-2040, Tx. 31 651 epo nl,
 Fax (+31-70) 340-3016

Authorized officer

Miller, A

INTERNATIONAL SEARCH REPORT

Information on patent family members

International Application No

PCT/US 01/15279

Patent document cited in search report	A	Publication date		Patent family member(s)	Publication date
US 5919468	A	06-07-1999	FR	2744911 A1	22-08-1997
				AT 192330 T	15-05-2000
				BR 9700264 A	27-10-1998
				DE 69701820 D1	08-06-2000
				DE 69701820 T2	12-10-2000
				EP 0790055 A1	20-08-1997
				ES 2148911 T3	16-10-2000
				JP 9227332 A	02-09-1997
US 5928660	A	27-07-1999	JP	10175816 A	30-06-1998
WO 9800105	A	08-01-1998	AU	3094897 A	21-01-1998
				CA 2257570 A1	08-01-1998
				WO 9800105 A1	08-01-1998
				EP 0914086 A1	12-05-1999
				JP 2000513367 T	10-10-2000
				US 5833973 A	10-11-1998
				US 5849314 A	15-12-1998
				ZA 9705623 A	28-12-1998
WO 9800104	A	08-01-1998	AU	3257797 A	21-01-1998
				CA 2257568 A1	08-01-1998
				WO 9800104 A1	08-01-1998
				EP 0914088 A1	12-05-1999
				JP 2000514423 T	31-10-2000
				US 6074672 A	13-06-2000
				ZA 9705680 A	28-12-1998